

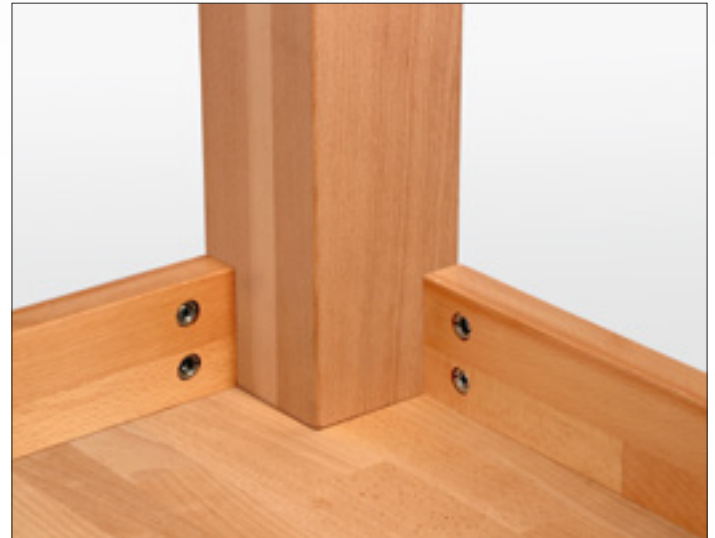

**INNOVATIVE**  
VERBINDUNGSSYSTEME

**XS-BESCHLAGSYSTEM AUS STAHL**

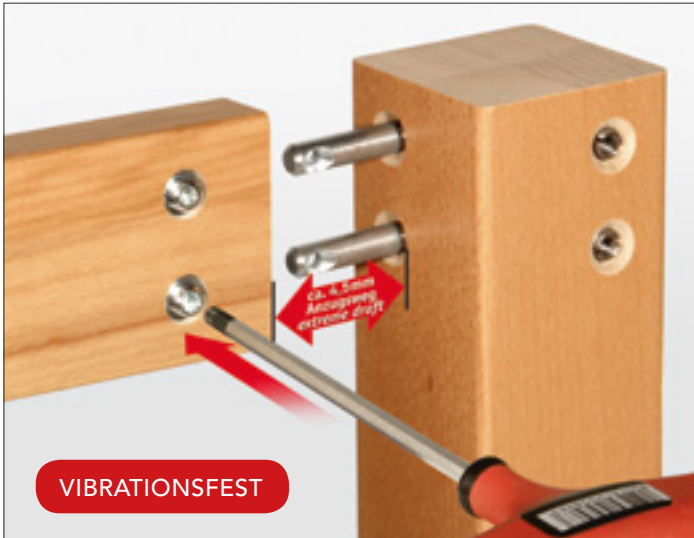

Extrem belastbarer Verbindungsbeschlag für beanspruchte Konstruktionen.

- Gehäuse Ø 10 mm
- Dübel Ø 10 mm
- Anzugsweg 4,5 mm
- Vibrationsfest
- Dauerhaft hoher Kraftschluss
- Leim und Holzdübel können entfallen
- Oberfläche verzinkt

## XS Gehäuse

Art. Nr.	Teile Nr.	Produktbezeichnung	Bohrtiefe a	Maß b	Preis per 10 Stk.	Preis per 100 Stk.
19136	J03 029	XS - Gehäuse Ø 15 x 17	17 mm	10 mm	€ 3.90	€ 39.60
19138	J01 550	XS - Gehäuse Ø 15 x 19	19 mm	12 mm	€ 4.10	€ 41.00
19139	J01 551	XS - Gehäuse Ø 15 x 21	21 mm	14 mm	€ 4.20	€ 42.00
19140	J01 552	XS - Gehäuse Ø 15 x 28	28 mm	13 mm	€ 4.60	€ 46.80

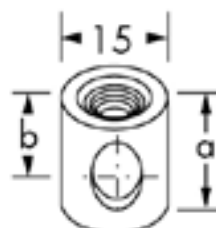

## XS Dübel

Art. Nr.	Teile Nr.	Produktbezeichnung	Bohrtiefe a	Maß b	Preis per 10 Stk.	Preis per 100 Stk.
19142	J01 112	XS Dübel Ø 10 x 30 M 6	37,5 mm	30 mm	€ 3.60	€ 27.80
19143	J01 087	XS Dübel Ø 10 x 30 M 8	37,5 mm	30 mm	€ 3.80	€ 29.00
19144	J01 088	XS Dübel Ø 10 x 33 Euro	40,0 mm	33 mm	€ 4.40	€ 34.00
19145	J01 612	XS Mittelwanddübel Ø 10 x 75	75,0 mm	60 mm	€ 4.80	€ 45.40

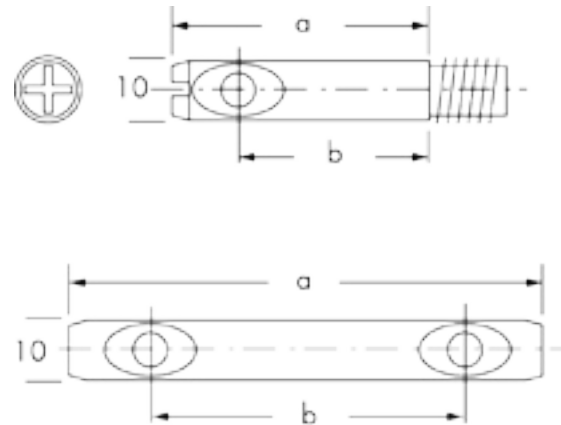

## XS Gewindestift

Art. Nr.	Teile Nr.	Produktbezeichnung	Antrieb ISK	Preis per 10 Stk.	Preis per 100 Stk.
19137	J03 006	XS Gew. Stift M 10 x 10 ISK	ISK - SW 5	€ 1.20	€ 9.00
19141	J01 549	XS Gew. Stift M 10 x 12 ISK	ISK - SW 5	€ 1.30	€ 9.10



## Einschraubmuffe

Art. Nr.	Teile Nr.	Produktbezeichnung	Antrieb ISK	Preis per 10 Stk.	Preis per 100 Stk.
19136	A00 006	Eindrehmuffe M 6 x 18 ISK	ISK - SW 6	€ 3.10	€ 23.50
19177	A00 008	Eindrehmuffe M 8 x 18 ISK	ISK - SW 8	€ 3.60	€ 27.00

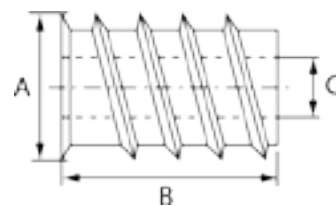



## XS - Beschlagsystem aus Stahl

Extrem belastbarer Verbindungsbeschlag für beanspruchte Konstruktionen wie zb. Betten, Rahmen usw.

- Gehäuse Ø 15 mm
- Dübel Ø 10 mm
- Vibrationsfest
- Anzugsweg 4 mm
- Dauerhaft hoher Kraftschluss
- kein seitliches Plattenverschieben
- Oberfläche verzinkt

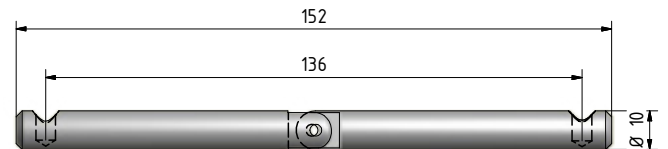

## XS - Gehrungsverbinder 2-seitig

Art. Nr.	Teile Nr.	Produktbezeichnung	Preis per 10 Stk.	Preis per 100 Stk.
19182	J02 402	XS Gehrungsverbinder 2-seitig	€ 17.60	€ 170.00

## XS Gehäuse

Art. Nr.	Teile Nr.	Produktbezeichnung	Bohrtiefe a	Maß b	Preis per 10 Stk.	Preis per 100 Stk.
19136	J03 029	XS - Gehäuse Ø 15 x 17	17 mm	10 mm	€ 3.90	€ 39.60
19138	J01 550	XS - Gehäuse Ø 15 x 19	19 mm	12 mm	€ 4.10	€ 41.00
19139	J01 551	XS - Gehäuse Ø 15 x 21	21 mm	14 mm	€ 4.20	€ 42.00
19140	J01 552	XS - Gehäuse Ø 15 x 28	28 mm	13 mm	€ 4.60	€ 46.80

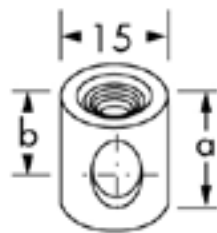

## XS Gewindestift

Art. Nr.	Teile Nr.	Produktbezeichnung	Antrieb ISK	Preis per 10 Stk.	Preis per 100 Stk.
19137	J03 006	XS Gew. Stift M 10 x 10 ISK	SW 5	€ 1.20	€ 9.00
19141	J01 549	XS Gew. Stift M 10 x 12 ISK	SW 5	€ 1.30	€ 9.10

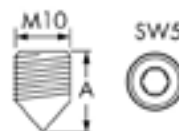
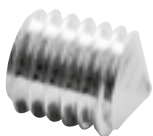

Alle Preise exkl. MwSt. | Satz- und Druckfehler vorbehalten

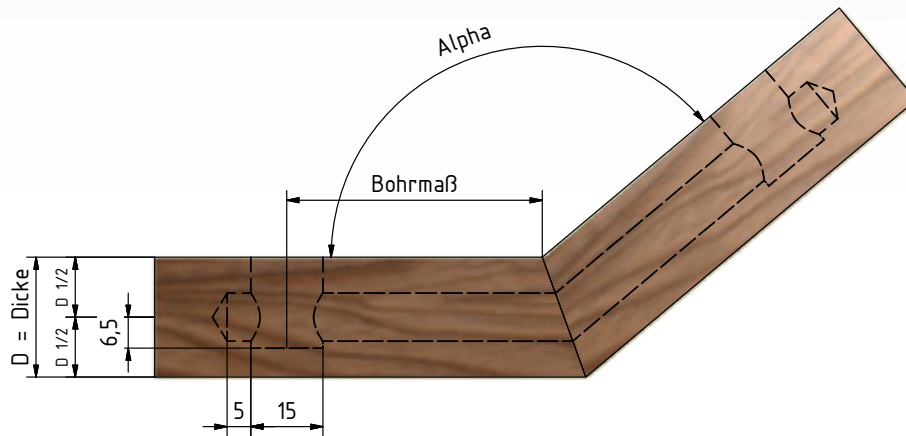

XS - Bohrabstand - Tabelle (ein Probeanschlag wird empfohlen)

Winkel $\alpha$	Materialstärke in mm				
	22	24	26	28	30
30	27.9	24.2	20.5	16.8	13.0
35	34.1	30.9	27.8	24.6	21.4
40	38.8	36.0	33.3	30.5	27.8
45	42.4	40.0	37.6	35.2	32.8
50	45.4	43.3	41.1	39.0	36.8
55	47.9	45.9	44.0	42.1	40.2
60	49.9	48.2	46.5	44.8	43.0
65	51.7	50.2	48.6	47.0	45.5
70	53.3	51.9	50.4	49.0	47.6
75	54.7	53.4	52.1	50.8	49.5
80	55.9	54.7	53.5	52.3	51.1
85	57.0	55.9	54.8	53.7	52.6
90	58.0	57.0	56.0	55.0	54.0
95	58.9	58.0	57.1	56.2	55.3
100	59.8	58.9	58.1	57.3	56.4
105	60.6	59.8	59.0	58.3	57.5
110	61.3	60.6	59.9	59.2	58.5
115	62.0	61.4	60.7	60.1	59.4
120	62.6	62.1	61.5	60.9	60.3
125	63.3	62.8	62.2	61.7	61.2
130	63.9	63.4	62.9	62.5	62.0
135	64.4	64.0	63.6	63.2	62.8
140	65.0	64.6	64.3	63.9	63.5
145	65.5	65.2	64.9	64.6	64.3
150	66.1	65.8	65.5	65.2	65.0
155	66.6	66.3	66.1	65.9	65.7
160	67.1	66.9	66.7	66.5	66.4
165	67.7	67.4	67.3	67.2	67.0
170	68.0	68.0	67.9	67.8	67.7
175	68.5	68.5	68.4	68.4	68.3
180	69.0	69.0	69.0	69.0	69.0



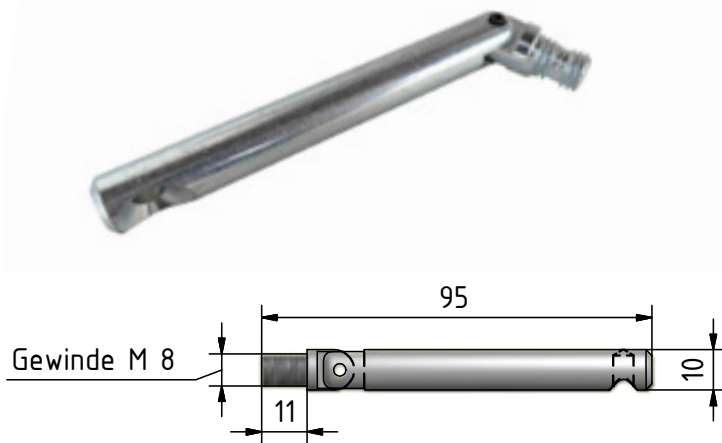

**XS - Beschlagsystem aus Stahl**

Extrem belastbarer Verbindungsbeschlag für beanspruchte Konstruktionen wie zb. Betten, Rahmen usw.

- Gehäuse Ø 15 mm
- Dübel Ø 10 mm
- Vibrationsfest
- Anzugsweg 4,5 mm
- Dauerhaft hoher Kraftschluss
- kein seitliches Plattenverschieben
- Oberfläche verzinkt

**XS - Gehrungsverbinder 1-seitig**

Art. Nr.	Teile Nr.	Produktbezeichnung	Preis per 10 Stk.	Preis per 100 Stk.
19183	J33 403	XS Gehrungsverbinder 1-seitig	€ 19.60	€ 190.00

**XS Gehäuse**

Art. Nr.	Teile Nr.	Produktbezeichnung	Bohrtiefe a	Maß b	Preis per 10 Stk.	Preis per 100 Stk.
19136	J03 029	XS - Gehäuse Ø 15 x 17	17 mm	10 mm	€ 3.90	€ 39.60
19138	J01 550	XS - Gehäuse Ø 15 x 19	19 mm	12 mm	€ 4.10	€ 41.00
19139	J01 551	XS - Gehäuse Ø 15 x 21	21 mm	14 mm	€ 4.20	€ 42.00
19140	J01 552	XS - Gehäuse Ø 15 x 28	28 mm	13 mm	€ 4.60	€ 46.80

**XS Gewindestift**

Art. Nr.	Teile Nr.	Produktbezeichnung	Antrieb ISK	Preis per 10 Stk.	Preis per 100 Stk.
19137	J03 006	XS Gew. Stift M 10 x 10 ISK	SW 5	€ 1.20	€ 9.00
19141	J01 549	XS Gew. Stift M 10 x 12 ISK	SW 5	€ 1.30	€ 9.10

Alle Preise exkl. MwSt. | Satz- und Druckfehler vorbehalten

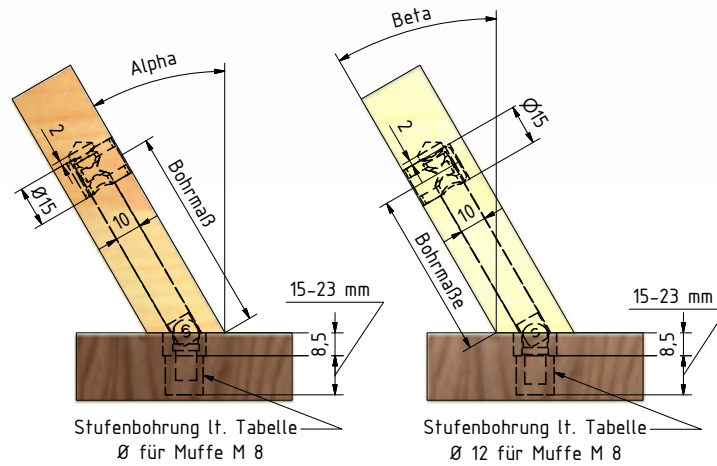

## XS - Bohrabstand - Tabelle (ein Probeanschlag wird empfohlen)

Winkel $\alpha$	Alpha Materialstärke in mm										Stufenbohrung
	20	22	24	26	28	30	32	34	36	38	
0	69.0	69.0	69.0	69.0	69.0	69.0	69.0	69.0	69.0	69.0	keine
5	69.9	70.0	70.0	70.1	70.2	70.3	70.4	70.5	70.6	70.7	keine
10	70.8	70.9	71.1	71.3	71.5	71.6	71.8	72.0	72.2	72.4	keine
15	71.7	71.9	72.2	72.5	72.8	73.0	73.3	73.6	73.8	74.1	keine
20	72.6	73.0	73.4	73.7	74.1	74.5	74.8	75.2	75.6	75.9	keine
25	73.7	74.1	74.6	75.1	75.5	76.0	76.5	76.9	77.4	77.9	keine
30	74.8	75.4	75.9	76.5	77.1	77.7	78.2	78.8	79.4	80.0	keine
35	76.0	76.7	77.4	78.1	78.8	79.5	80.2	80.9	81.6	82.3	16
40	77.4	78.2	79.1	79.9	80.7	81.6	82.4	83.3	84.1	84.9	16
45	79.0	80.0	81.0	82.0	83.0	84.0	85.0	86.0	87.0	88.0	16
50	80.9	82.1	83.3	84.5	85.7	86.9	88.1	89.3	90.5	91.6	20
55	83.3	84.7	86.1	87.6	89.0	90.4	91.9	93.3	94.7	96.1	20
60	86.3	88.1	89.8	91.5	93.2	95.0	96.7	98.4	100.2	101.9	20

## XS - Bohrabstand - Tabelle (ein Probeanschlag wird empfohlen)

Winkel $\beta$	Beta Materialstärke in mm										Stufenbohrung
	20	22	24	26	28	30	32	34	36	38	
0	69.0	69.0	69.0	69.0	69.0	69.0	69.0	69.0	69.0	69.0	keine
5	68.1	68.0	68.0	67.9	67.8	67.7	67.6	67.5	67.4	67.3	keine
10	67.2	67.1	66.9	66.7	66.5	66.4	66.2	66.0	65.8	65.6	keine
15	66.3	66.1	65.8	65.5	65.2	65.0	64.7	64.4	64.2	63.9	keine
20	65.4	65.0	64.9	64.3	63.9	63.5	63.2	62.8	62.4	62.1	keine
25	64.3	63.9	63.4	62.9	62.5	62.0	61.5	61.1	60.6	60.1	keine
30	63.2	62.6	62.1	61.5	60.9	60.3	59.8	59.2	58.6	58.0	keine
35	62.0	61.3	60.6	59.9	59.2	58.5	57.8	57.1	56.4	55.7	16
40	60.6	59.8	58.9	58.1	57.3	56.4	55.6	54.7	53.9	53.1	16
45	59.0	58.0	57.0	56.0	55.0	54.0	53.0	52.0	51.0	50.0	16
50	57.1	55.9	54.7	53.5	52.3	51.1	49.9	48.7	47.5	46.4	20
55	54.7	53.3	51.9	50.4	49.0	47.6	46.1	44.7	43.3	41.9	20
60	51.7	49.9	48.2	46.5	44.8	43.0	41.3	39.6	37.8	36.1	20

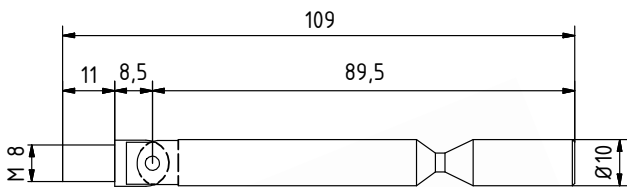
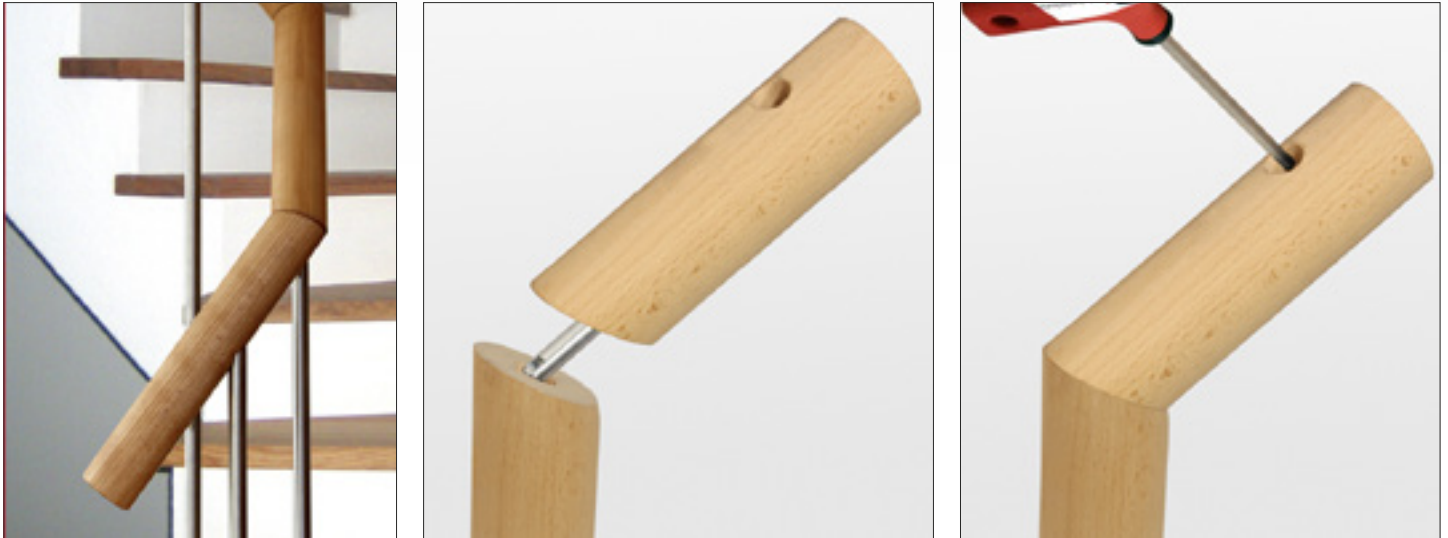

## XS - Handlaufverbinder aus Stahl

Extrem belastbarer Verbindungsbeschlag für beanspruchte Konstruktionen wie zb. Handläufe

- Gehäuse  $\varnothing$  15 mm
- Dübel  $\varnothing$  10 mm
- Vibrationsfest
- Anzugsweg 4,5 mm
- Dauerhaft hoher Kraftschluss
- Oberfläche verzinkt

## XS Dübel für Handläufe - gehärtet

Art. Nr.	Teile Nr.	Produktbezeichnung	$\varnothing$ Dübel	Länge	Preis per 10 Stk.	Preis per 100 Stk.
19187	J03 237	XS Dübel - gehärtet	$\varnothing$ 10 mm	109 mm	€ 47.90	€ 454.80

## XS Gehäuse

Art. Nr.	Teile Nr.	Produktbezeichnung	Bohrtiefe a	Maß b	Preis per 10 Stk.	Preis per 100 Stk.
19136	J03 029	XS - Gehäuse $\varnothing$ 15 x 17	17 mm	10 mm	€ 3.90	€ 39.60
19138	J01 550	XS - Gehäuse $\varnothing$ 15 x 19	19 mm	12 mm	€ 4.10	€ 41.00
19139	J01 551	XS - Gehäuse $\varnothing$ 15 x 21	21 mm	14 mm	€ 4.20	€ 42.00
19140	J01 552	XS - Gehäuse $\varnothing$ 15 x 28	28 mm	13 mm	€ 4.60	€ 46.80

## XS Gewindestift

Art. Nr.	Teile Nr.	Produktbezeichnung	Antrieb ISK	Preis per 10 Stk.	Preis per 100 Stk.
19137	J03 006	XS Gew. Stift M 10 x 10 ISK	SW 5	€ 1.20	€ 9.00
19141	J01 549	XS Gew. Stift M 10 x 12 ISK	SW 5	€ 1.30	€ 9.10





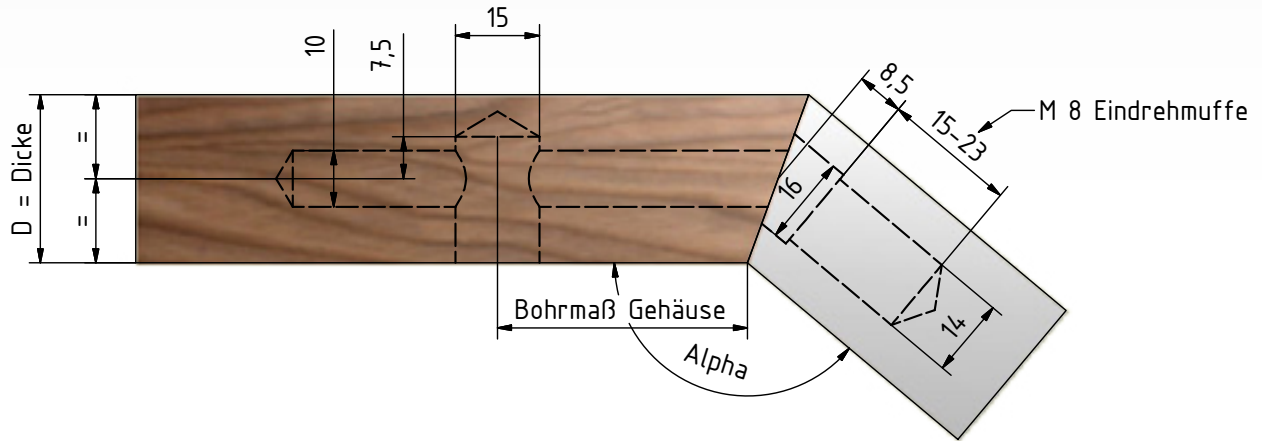

XS - Bohrabstand - Tabelle für Handläufe (ein Probeanschlag wird empfohlen)

Winkel $\alpha$	Materialstärke in mm / D												
	30	32.5	35	37.5	40	42.5	45	47.5	50	52.5	55	57.5	60
55	37.2	34.8	32.4	30.0	27.6	25.2	22.8	20.4	18.0	15.6	13.2	10.8	8.4
60	40.0	37.9	35.7	33.5	31.4	29.2	27.0	24.9	22.7	20.5	18.4	16.2	14.0
65	42.5	40.5	38.5	36.6	34.6	32.6	30.7	28.7	26.8	24.8	22.8	20.9	18.9
70	44.6	42.8	41.0	39.2	37.4	35.7	33.9	32.1	30.3	28.5	26.7	24.9	32.2
75	46.5	44.8	53.2	41.6	39.9	38.3	36.7	35.0	33.4	31.8	30.2	28.5	26.9
80	48.1	46.6	45.1	43.7	42.2	40.7	39.2	37.7	36.2	34.7	33.2	31.7	30.2
85	49.6	48.3	46.9	45.5	44.2	42.8	41.4	40.1	38.7	37.4	36.0	34.6	33.3
90	51.0	49.8	48.5	47.3	46.0	44.8	43.5	42.3	41.0	39.8	38.5	37.3	36.0
95	52.3	51.1	50.0	48.8	47.7	46.5	45.4	44.2	43.1	41.9	40.8	39.7	38.5
100	53.4	52.4	51.3	50.3	49.2	48.2	47.1	46.1	45.0	44.0	42.9	41.9	40.8
105	54.5	53.5	52.6	51.6	50.7	49.7	48.7	47.8	46.8	45.9	44.9	43.9	43.0
110	55.5	54.6	53.7	52.9	52.0	51.1	50.2	49.4	48.5	47.6	46.7	45.9	45.0
115	56.4	55.6	54.9	54.1	53.3	52.5	51.7	50.9	50.1	49.3	48.5	47.7	46.9
120	57.3	56.6	55.9	55.2	54.5	53.7	53.0	52.3	51.6	50.8	50.1	49.4	48.7
125	58.2	57.5	56.9	56.2	55.6	54.9	54.3	53.6	53.0	52.3	51.7	51.0	50.4
130	59.0	58.4	57.8	57.3	56.7	56.1	55.5	54.9	54.3	53.8	53.2	52.6	52.0
135	59.8	59.3	58.8	58.2	57.7	57.2	56.7	56.2	55.6	55.1	54.6	54.1	53.6
140	60.5	60.1	59.6	59.2	58.7	58.3	57.8	57.4	56.9	56.4	56.0	55.5	55.1
145	61.3	60.9	60.5	60.1	59.7	59.3	58.9	58.5	58.1	57.7	57.3	56.9	56.5
150	62.0	61.6	61.3	61.0	60.6	60.3	60.0	59.6	59.3	59.0	58.6	58.3	58.0
155	62.7	62.4	62.1	61.8	61.6	61.3	61.0	60.7	60.5	60.2	59.9	59.6	59.3
160	63.4	63.1	62.9	62.7	62.5	62.3	62.0	61.8	61.6	61.4	61.2	60.9	60.7
165	64.0	63.9	63.7	63.5	63.4	63.2	63.0	62.9	62.7	62.5	62.4	62.2	62.1
170	64.7	64.6	64.5	64.4	64.3	64.1	64.0	63.9	63.8	63.7	63.6	63.5	63.4
175	65.3	65.3	65.2	65.2	65.1	65.1	65.0	65.0	64.9	64.9	64.8	64.7	64.7
180	66.0	66.0	66.0	66.0	66.0	66.0	66.0	66.0	66.0	66.0	66.0	66.0	66.0

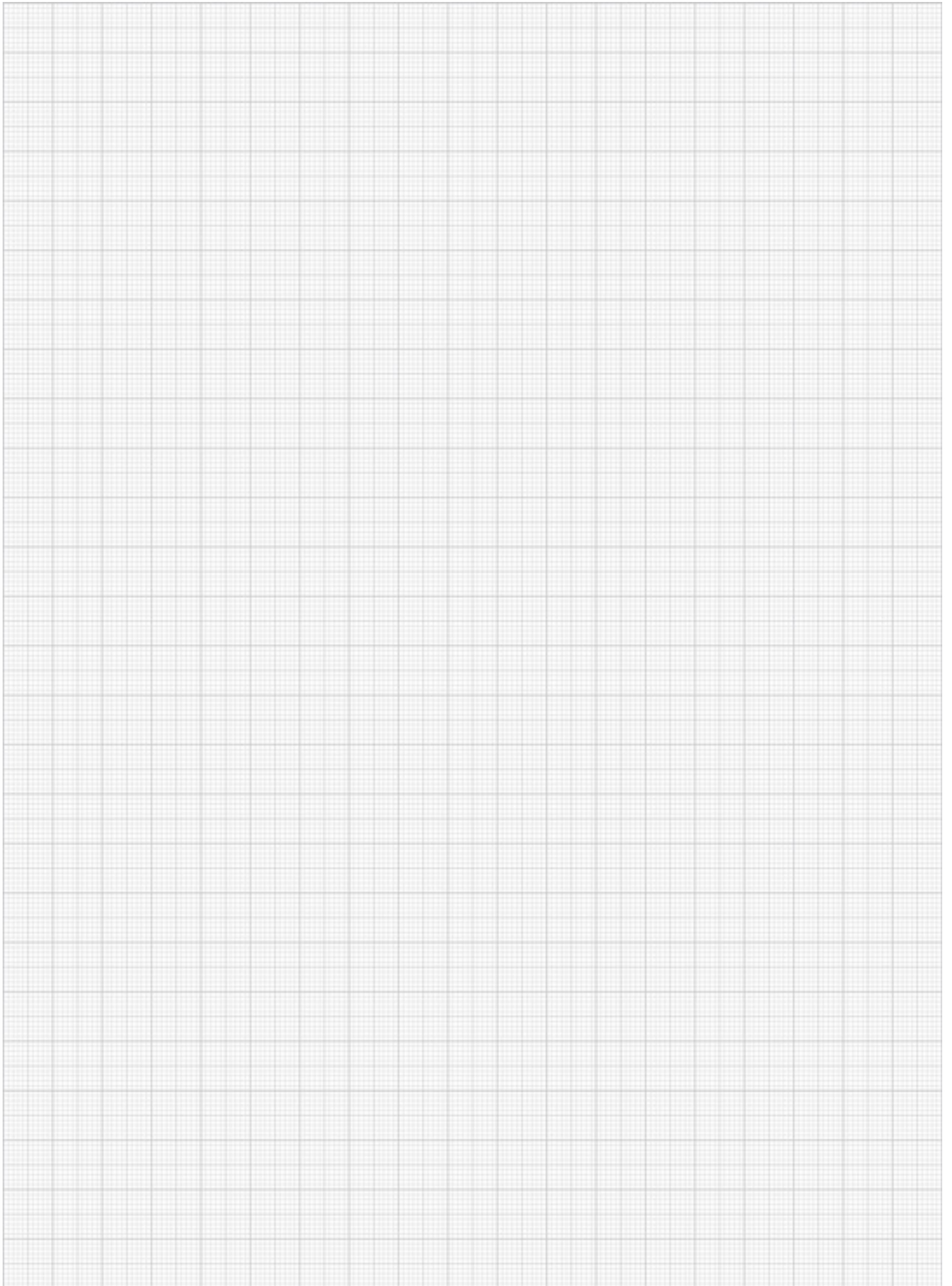

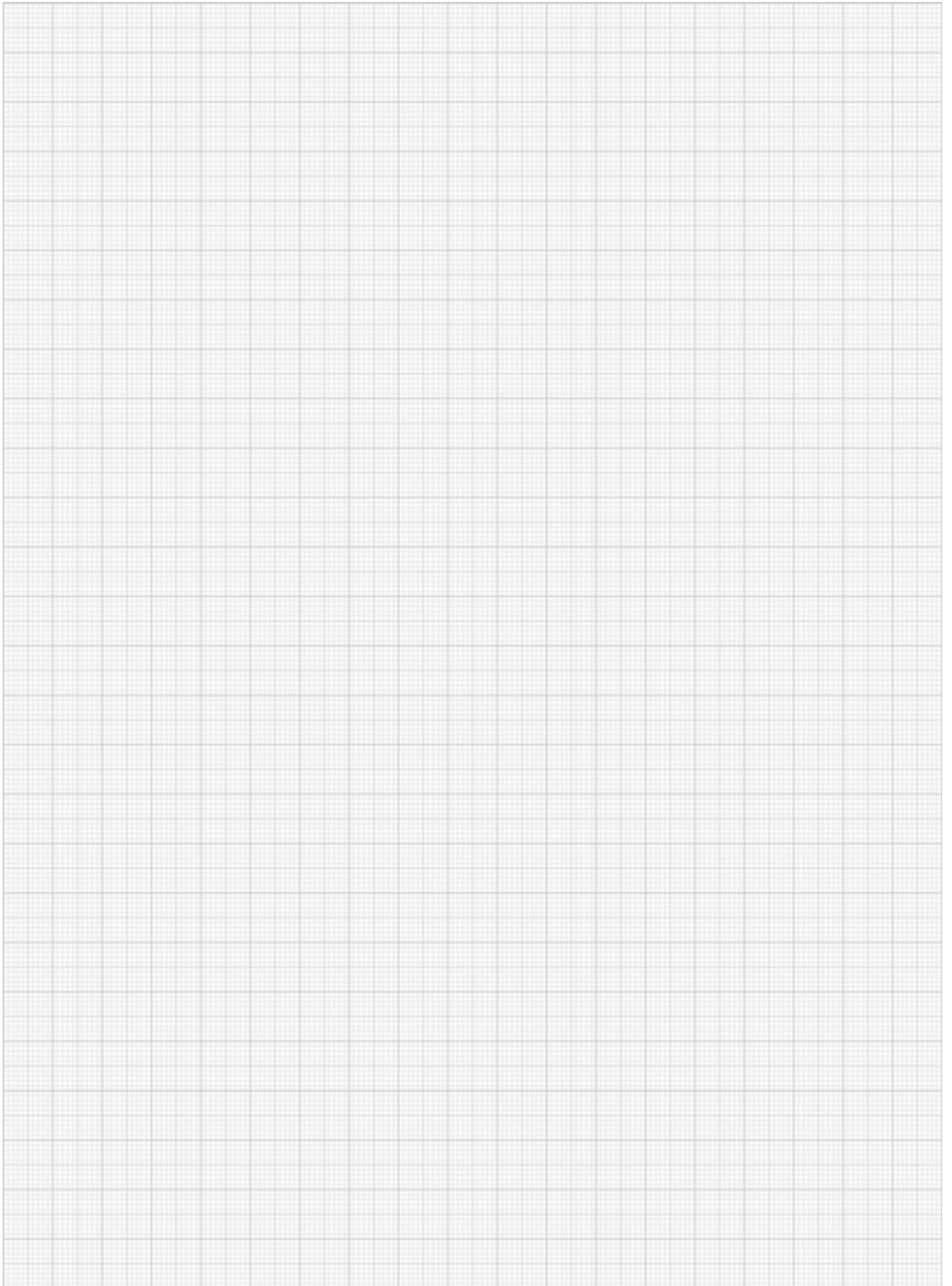

## PREISLISTE GÜLTIG AB 1. 3. 2016 BIS AUF WIEDERRUF.

Dieses Dokument ist alleiniges Eigentum der BTA GmbH und unterliegt unseren Allgemeinen Geschäftsbedingungen, nachzulesen auf unserer Webseite unter [www.beschlag-technik.com](http://www.beschlag-technik.com). Vervielfältigungen, Reproduktionen oder Veröffentlichungen, auch auszugsweise, sind nur mit schriftlicher Zustimmung der BTA GmbH zulässig. Satz- & Druckfehler, sowie Irrtümer vorbehalten.

Alle Rechte vorbehalten. © 2016 - BTA GmbH.

[WWW.BESCHLAG-TECHNIK.COM](http://WWW.BESCHLAG-TECHNIK.COM)



BTA GmbH - BESCHLAG TECHNIK AUSTRIA  
Adresse: Kasten 53, A-4171 St. Peter am Wimberg  
+43 660 48 248 15 | [office@beschlag-technik.com](mailto:office@beschlag-technik.com)

